



StrongArm®

12 Volt DC ELECTRIC WINCHES

OWNER'S MANUAL



MODELS SA5000, SA5015, SA7000, SA7015, SA9000, SA9015, SA12000, SA12015

⚠ WARNING: READ INSTRUCTIONS CAREFULLY BEFORE ATTEMPTING TO INSTALL, OPERATE OR SERVICE THE *STRONGARM* ELECTRIC WINCH. FAILURE TO COMPLY WITH INSTRUCTIONS COULD RESULT IN SERIOUS OR FATAL INJURY. RETAIN INSTRUCTIONS FOR FUTURE REFERENCE.



WINCH RATINGS

ELECTRIC WINCH RATING*

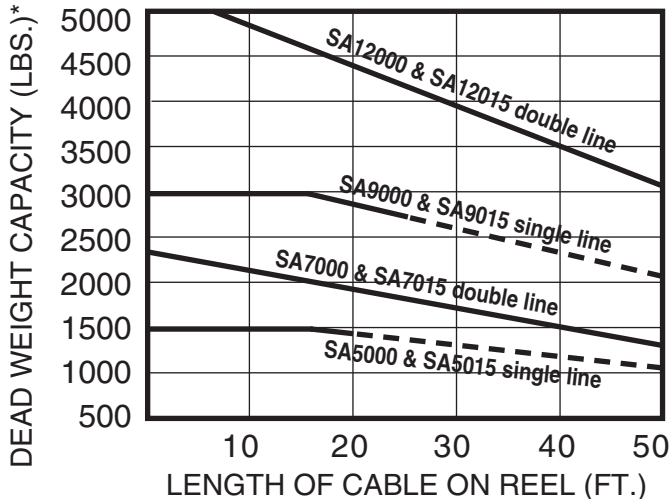

DOUBLE LINE OPERATION

Models SA7000, SA7015, SA12000 and SA12015 are factory equipped with a pulley block and hook and 50' of cable for double line operation. This increases the pulling capacity of the winch as shown, however, care must be taken to allow adequate motor cooling. Note that with double line, a pull of 25' requires reeling in 50' of cable.

For intermittent use only. Ratings at left are based on 10' pull. For longer pulls motor cooling periods must be allowed.

MAXIMUM CONTINUOUS RUN TIME 4 MINUTES

⚠ CAUTION: CONTINUOUS RUNNING IN EXCESS OF 4 MINUTES WILL DAMAGE WINCH MOTOR.

GUIDE TO ROLLING LOAD CAPACITY** Maximum weight in pounds and kilograms rolling load.

MODEL	PERCENT INCLINE						LOAD CAPACITY
	5% (3°)	10% (6°)	20% (11°)	30% (17°)	50% (26°)	70% (35°)	
SA5000 SA5015	10,000 lbs. 4,536 kg	7,500 lbs. 3,402 kg	5,100 lbs. 2,313 kg	3,900 lbs. 1,769 kg	2,700 lbs. 1,225 kg	2,200 lbs. 998 kg	1500 lbs. 680 kg
SA7000 SA7015	14,600 lbs. 6,623 kg	11,000 lbs. 4,990 kg	7,400 lbs. 3,357 kg	5,700 lbs. 2,586 kg	4,000 lbs. 1,814 kg	3,300 lbs. 1,497 kg	2200 lbs. 998 kg
SA9000 SA9015	20,000 lbs. 9,072 kg	15,000 lbs. 6,804 kg	10,200 lbs. 4,627 kg	7,700 lbs. 3,493 kg	5,500 lbs. 2,495 kg	4,500 lbs. 2,041 kg	3,000 lbs. 1,361 kg
SA12000 SA12015	30,000 lbs. 13,608 kg	22,600 lbs. 10,251 kg	15,200 lbs. 6,895 kg	11,600 lbs. 5,262 kg	8,300 lbs. 3,765 kg	6,800 lbs. 3,084 kg	4,500 lbs. 2,041 kg

APPROXIMATE LOAD SPEED (FT./MIN.)

MODEL	NO LOAD		FULL LOAD	
	Full Reel	Empty Reel	Full Reel	Empty Reel
SA5000 SA5015	33	12	8	4
SA7000 SA7015	16	6	4.5	3.5
SA9000 SA9015	11	5	4	2.5
SA12000 SA12015	5	2.5	2	1.5

⚠ WARNING: NOT TO BE USED AS A HOIST FOR LIFTING, SUPPORTING OR TRANSPORTING PEOPLE OR LOADS OVER AREAS WHERE PEOPLE COULD BE PRESENT!

(*) Load capacity (dead weight) is a measure of actual maximum force to which the winch system may be subjected.

(**) All capacities shown are with 15' of cable on the reel and 10% rolling friction factor. For full reel of cable adjust capacities according to graph above. Note 5% incline is one-half foot rise in ten feet.

ENGLISH

ESPAÑOL

FRANÇAIS

IMPORTANT SAFETY INFORMATION

⚠ WARNING: FAILURE TO READ AND FOLLOW INSTRUCTIONS BELOW COULD RESULT IN SERIOUS OR FATAL INJURY.

⚠ WARNING: NOT TO BE USED AS A HOIST FOR LIFTING, SUPPORTING, OR TRANSPORTING PEOPLE OR LOADS OVER AREAS WHERE PEOPLE COULD BE PRESENT.

⚠ This winch is not designed for movement of human beings. Do not use for scaffolding, elevators, or any other application in which persons could be positioned on or under the load at any time. Do not use as an overhead hoist.

⚠ Consult the manufacturer before using this winch in any vertical lifting/lowering applications. Tel. 402-462-4141, Fax 402-460-4613. E-Mail dlsales@dutton-lainson.com

⚠ This electric winch should be respected as power equipment. High forces are created when using a winch, creating potential safety hazards. Never allow children or anyone who is not familiar with the operation of the winch to use it.

⚠ Never exceed rated winch load. Dangerously high forces can be created if the load being moved is too large or is allowed to get in a bind, etc. Note that installing longer than normal cable results in increased load on winch. If overloaded, this winch has power enough to break the cable.

⚠ Winch is equipped with a high-quality aircraft cable capable of handling the rated winch load. Never exceed the rated capacity. Do not use vehicle pulling power to increase the pulling capacity of your winch. When cable breakage occurs under tension, the cable tends to whip toward the winch area. It is recommended that a blanket or rug be placed over the cable during winching operations to minimize this whipping action in case of cable breakage.

⚠ Never apply load to winch with cable fully extended. Keep at least three turns of cable on the reel.

⚠ Keep the winching area free of all unnecessary personnel. Never stand between load and winch.

⚠ The 12 volt D.C. winches operate from a low voltage D.C. source of power (e.g., a car or truck battery). DO NOT connect winch to 120V A.C. power.

⚠ When winching operation has been completed, do not depend on the winch to support the load. Always secure the load properly. Use tie down straps or chains.

⚠ The auxiliary handle is provided for emergency use only. Never use the auxiliary handle as an assist to the motor when the motor is running. Always remove the auxiliary handle when it is not in use. Do not operate the winch motor or allow the winch to free wheel with the handle installed.

⚠ Keep hands and fingers clear of the drum and cable area of the winch when operating. Do not attempt to guide the cable by hand as it rewinds on the drum.

⚠ The winch must be securely attached to a structural member or frame that is capable of sustaining loads in excess of the winch capacity. When attaching the winch to a vehicle, make sure the mounting pad area is rigidly supported by the vehicle frame. Always block the wheels to prevent vehicle from rolling when pulling a load with the winch.

⚠ When releasing a load with the clutch, maintain control of the speed. Excess speed could result in winch damage and serious personal injury.

MOUNTING INSTRUCTIONS

1. Be sure that the mounting surface is of sufficient strength to support a load well in excess of the rated winch capacity.
2. Fasten the winch to the trailer winch stand (or other mounting surface) with three 1/2" bolts, nuts, washers and lock washers. Be sure that the winch is positioned so that the cable does not rub the front opening of the winch.
3. On boat trailer installations the winch stand should be adjusted so that the loading ring on the bow of the boat is at the same height or slightly higher than the winch drum when the boat is fully loaded on the trailer. Be sure that the trailer-bow stop is located far enough back of the winch drum so that the cable hook is not drawn into the drum when the boat is fully loaded on the trailer.
4. For double line use, install an eyehook on the winch stand close to the base of the winch for fastening the stationary cable hook. (see Fig. 1) Be sure the eyehook is of sufficient strength to withstand loads in excess of the single line rating of the winch.

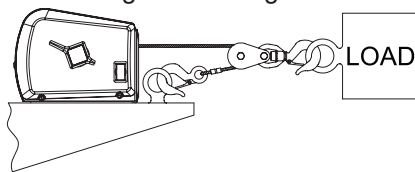

FIG. 1

5. Your winch is equipped with keyhole slots in the base for use with quick mounting shoulder studs, if desirable. (See FIG. 2&3) If you wish to use quick mount studs, they should be mounted securely into the winch stand. After positioning the winch on the studs, a 3/8" bolt should be placed in one of the other holes available to keep the winch securely in position.

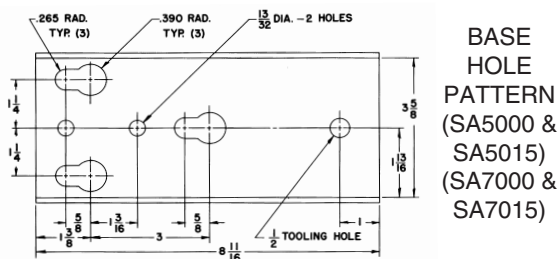

FIG. 2

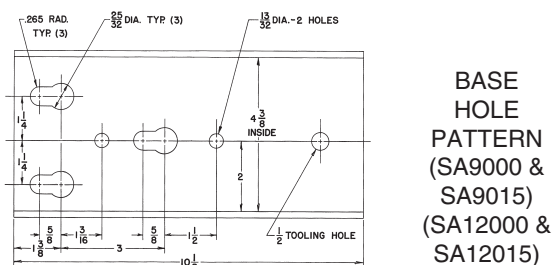

FIG. 3

WIRING HARNESS INSTALLATION

The wiring harness is designed to remain in the towing vehicle when not in use. This prevents tampering, accident or misuse since the harness is needed to operate the winch electrically.

These installation instructions provide ready access for use, yet allow the complete harness to be quickly removed if desired.

1. Feed positive lead (long) wire only through any convenient access hole inside the car trunk. It may be necessary to remove a knockout plug or rubber grommet from the trunk floor. It may also be necessary to remove the circuit breaker assembly from the positive wire in order to feed the wire under the car.
2. Pull the positive lead wire along the underside of the car into the engine compartment and up to the battery. Fasten the wire to the car undercarriage with existing wiring clamps and brackets, making sure wire is not located near the exhaust system, or any hot or moving parts. Wire should be fastened securely and without slack. Excess wire should remain in the trunk.
3. Fasten the circuit breaker to the positive (+) battery terminal (if nut and bolt type) or to the battery side of the starter solenoid.
4. Attach negative wire to vehicle frame using a 1/4" bolt and locknut. Make sure you have a clean, tight connection.

NOTE: If winch is to be mounted in front of vehicle, cut harness to the length needed making sure, if spliced, the splice is tight and well insulated. Attach ground as described in 4 above.

LOADING AND UNLOADING UNDER POWER

1. With the wires at the bottom, push the switch into the pocket in the winch housing. The switch should push easily to the bottom of the pocket and excess force should not be required for installation or removal of the switch. Be sure that the wires are free to rotate with the switch so that it will return to its center "off" position when released. Leave your car engine running on fast idle as a precaution in case the battery is not in top condition.
2. With the clutch lever in the engaged gears position, you may power the winch in either the load or unload direction. Allowing the switch to return to the OFF position will automatically stop the winch and lock the load in position.

NOTE: It is normal for smoke to be produced during the initial power down use.

WARNING: EVEN THOUGH THE WINCH IS EQUIPPED WITH CIRCUIT BREAKER OVERLOAD PROTECTION, PARTICULAR CARE SHOULD BE TAKEN NOT TO CREATE AN OVERLOAD. PAY ATTENTION TO THE SOUND OF THE WINCH AND THE LOAD BEING PULLED. MAKE CERTAIN THAT THE CABLE TENSION DOES NOT RISE SUDDENLY BECAUSE OF A BIND IN THE LOAD.

CAUTION: The electric motor is designed for intermittent service only. Extended use without cooling off periods will cause overheating resulting in motor damage. Maximum recommended continuous run time is four minutes.

3. Slots are available in the switch handle for the attachment of a remote lanyard if desirable. This allows operation of the winch at a distance by pulling on the lanyard to rotate the switch.
4. When the unit is used to trailer a boat, secure the boat onto the trailer with appropriate bow and transom tie down straps or chains. With the boat fully

secured on the trailer, it is advisable to relieve the tension on the winch cable to avoid damage to the winch and trailer due to high shock loads encountered when traveling.

5. Always disconnect the switch when the winching operation is complete. Never leave the switch connected to the winch when not in use.

CLUTCH OPERATION

1. The clutch lever provides a means for releasing a load without power while maintaining control of the speed and provides for free wheeling so that cable can be removed from the winch by hand. The clutch lever is spring loaded so that it returns to the engaged position when released. The lever will, however, remain in the free wheeling position if rotated completely forward to free wheel.
2. In order to release a load without power, rotate the clutch lever slowly and carefully forward toward "Free Wheel." When the load begins to move, it can be controlled by the clutch lever. Careful, slow movement of the lever will provide smooth control of the load.

⚠ WARNING: ALWAYS MAINTAIN CONTROL OF THE LOAD. ALLOWING EXCESS SPEED COULD RESULT IN WINCH DAMAGE AND SEVERE PERSONAL INJURY.

3. Remember that the gear train and brake mechanism are completely disengaged in the "Free Wheel" position and in order to power the winch or hold a load in position, the lever must be allowed to return to the "Engaged Gears" position.

NOTE: It is not necessary to turn the clutch lever completely to the "Engaged Gears" position manually. The spring tension built into the winch provides adequate force on the clutch lever.

⚠ CAUTION: Never force clutch lever in either direction.

AUXILIARY HANDLE

1. An emergency crank handle is provided for use in the event of a power failure. Remove the electrical power from the winch.

⚠ WARNING: NEVER OPERATE THE WINCH ELECTRICALLY WITH THE EMERGENCY HANDLE IN POSITION.

2. Remove the plastic plug from the side of the winch housing and insert the handle so that it completely engages with the drive shaft. The handle can be cranked in either direction with the clutch in the engaged position. To make cranking easier, the clutch can be placed in the free wheel position while holding onto the emergency handle.

⚠ WARNING: IF THE CLUTCH IS PLACED IN FREE WHEEL FOR HAND CRANKING, BE SURE TO MAINTAIN A FIRM GRIP ON THE HANDLE AT ALL TIMES.

Because the emergency crank handle for models SA9000, SA9015, SA12000 and SA12015 attaches to the clutch side of the winch, it is equipped with a spring operated clip which

will be depressed by the clutch handle in the free wheel position when cranking in a clockwise direction to retrieve the cable. This clip is a safety feature and will re-engage the clutch mechanism in the event that the operator loses control of the handle with a load on the winch. (See FIG. 4)

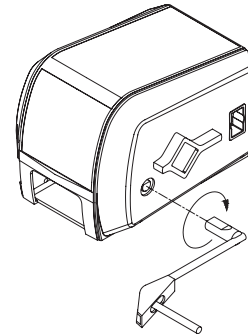

Emergency Handle Illustration

FIG. 4

⚠ WARNING: EVEN WITH THIS SAFETY FEATURE THE HANDLE WILL STILL SPIN VIOLENTLY ONE OR TWO TURNS BEFORE RE-ENGAGING THE CLUTCH TO STOP THE WINCH. DO NOT LOSE CONTROL.

3. Always remove the handle from the winch after use and replace the plastic plug.

WINCH MAINTENANCE

For long life and trouble-free operation your winch should periodically be inspected for any required maintenance. This should be done at least once annually and more frequently in adverse conditions such as salt water areas or areas of extreme dust and dirt.

1. Carefully inspect the winch cable for any kinks, frays or abnormal stiffness and replace at the first sign of this kind of damage. **Go to Dutton-Lainson website: <http://www.dutton-lainson.com/ts.php> for trouble shooting manual, select winch model number and click on symptom "Cable Damage" for complete diagnoses and corrective action.** Periodic lubrication with a light oil will improve the life of the cable. In order to replace the winch cable, it is necessary to remove the clutch handle, by removing the two clutch handle screws, and the four cover mounting bolts. Be sure that the power is disconnected from the housing and lift the housing off of the winch by gently stretching it open near the lower front corner. Rotate the winch reel so that you have access to the rope clamp. Remove the old cable and replace it with a new cable of the same size. Be sure that the cable passes under both sides of the rope clamp and that the clamp is tightened securely.

NOTE: CABLE IS WOUND OVER THE TOP OF THE DRUM ON MODELS SA5000, SA5015, SA7000 AND SA7015 UNDER THE DRUM ON MODELS SA9000, SA9015, SA12000 and SA12015. SEE ATTACHMENT METHOD BELOW (FIG. 5).

CABLE ATTACHMENT METHODS

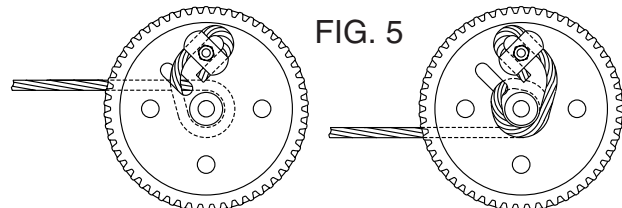
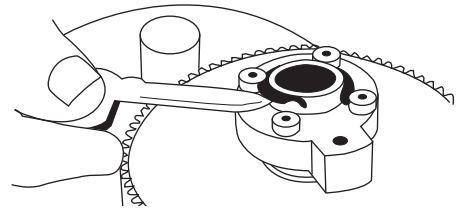

FIG. 5

**Model SA5000, SA5015
SA7000, SA7015**

**Model SA9000, SA9015
SA12000, SA12015**

2. With the cover removed as described above, inspect the entire gear train and all drive shafts for any significant wear or loose bearing fits. Grease all of the gears on the inside of the winch base and apply a drop of oil on all of the bearings in the base. Also, very sparingly oil all of the bearings in the clutch mechanism and place a drop of oil on the roller clutch. Do not over lubricate these areas and do not use grease in the roller clutch. The clutch mechanism and the brake pads and brake disc must be kept clean and oil free.
3. Check the operation of the roller clutch. Carefully rotate the brake disc and observe the motor shaft. When the disc is turned clockwise the motor shaft should turn with it. When the disc is turned counter-clockwise the motor shaft should not turn. Also, check all nuts, bolts, retaining rings, etc., to be sure that they are tight and secure.
4. Check the switch contact studs in the winch housing to be sure that they are free from any corrosion or excessive electrical pitting. Make sure that the housing shunt spring is properly in place and making contact with both contact pins. **Go to Dutton-Lainson website: <http://www.dutton-lainson.com/ts.php> for trouble shooting manual, select winch model number and click on symptoms "Motor will not run in either direction" and "Motor runs in only one direction" for complete diagnoses and corrective action.**
5. If the clutch has been slipping and requires adjustment the following procedures should be used. The clutch is adjustable in ten degree increments. With a screwdriver and pliers, remove the end of the clutch spring from the hole in the winch base. The spring tension is quite high so be careful to maintain a firm grip on the spring. The O-ring should be rotated so that the cut out portions align with the lugs on the spring keeper. (See FIG. 6)



O-Ring Illustration

FIG. 6

the cut outs are not in line with the lugs on the spring keeper and reinstall the clutch spring into the hole in the base. Adjustment of the clutch more than 10 degrees to 20 degrees should normally not be necessary. With only spring pressure (do not forcibly tighten the clutch mechanism) the spring lug on the spring keeper should come to rest at approximately the 2:30 o'clock position. (See FIG. 7).

Go to Dutton-Lainson website: <http://www.dutton-lainson.com/ts.php> for trouble shooting manual, select winch model number and click on symptom "Motor runs but winch fails to pull cable" for complete diagnoses and corrective action.

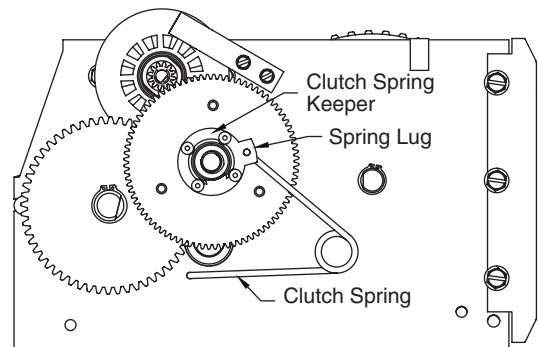

FIG. 7

Clutch Spring Illustration

6. Check the pulley block and hook assembly (Models SA7000, SA7015, SA12000 and SA12015) to be sure that the pulley rotates freely on the bronze pulley spacer. Occasional greasing of these two items is recommended.

If you are having any problems with this electric winch, go to Dutton-Lainson website: <http://www.dutton-lainson.com/ts.php> to view trouble shooting manual. This manual will help diagnose most problems with this winch.



E
N
G
L
I
S
H

DECLARATION OF CONFORMITY - Dutton-Lainson Company, Hastings, NE 68902-0729 U.S.A. manufacturers and declares that the winch identified above fulfills all relevant provisions of the Directive 2006/42/EC, and Supply of Machinery (Safety) Regulations 2008. The technical file may be obtained from the persons listed below.

Hastings, NE USA
November 22, 2022

Director of Engineering
Dutton-Lainson Company

Jack Singleton
Eurowarehouse BV
De Amstel 11
8253PC Dronten
The Netherlands

NOTES

WINCH MODEL NUMBER: _____ WINCH DATE CODE: _____

DATE PURCHASED: _____ (LOCATED INSIDE FRAME AT REAR)



A Dependable Company Since 1886
DUTTON-LAINSON COMPANY
Hastings, NE 68902 U.S.A • Tel 402-462-4141 • Fax 402-460-4612
E-mail dlsales@dutton-lainson.com • Web Site www.dutton-lainson.com

**MADE IN
USA**