

MODEL  
DLC600

600lb/272kg CAPACITY  
PULLING WINCH

FRONT & SIDE VIEW

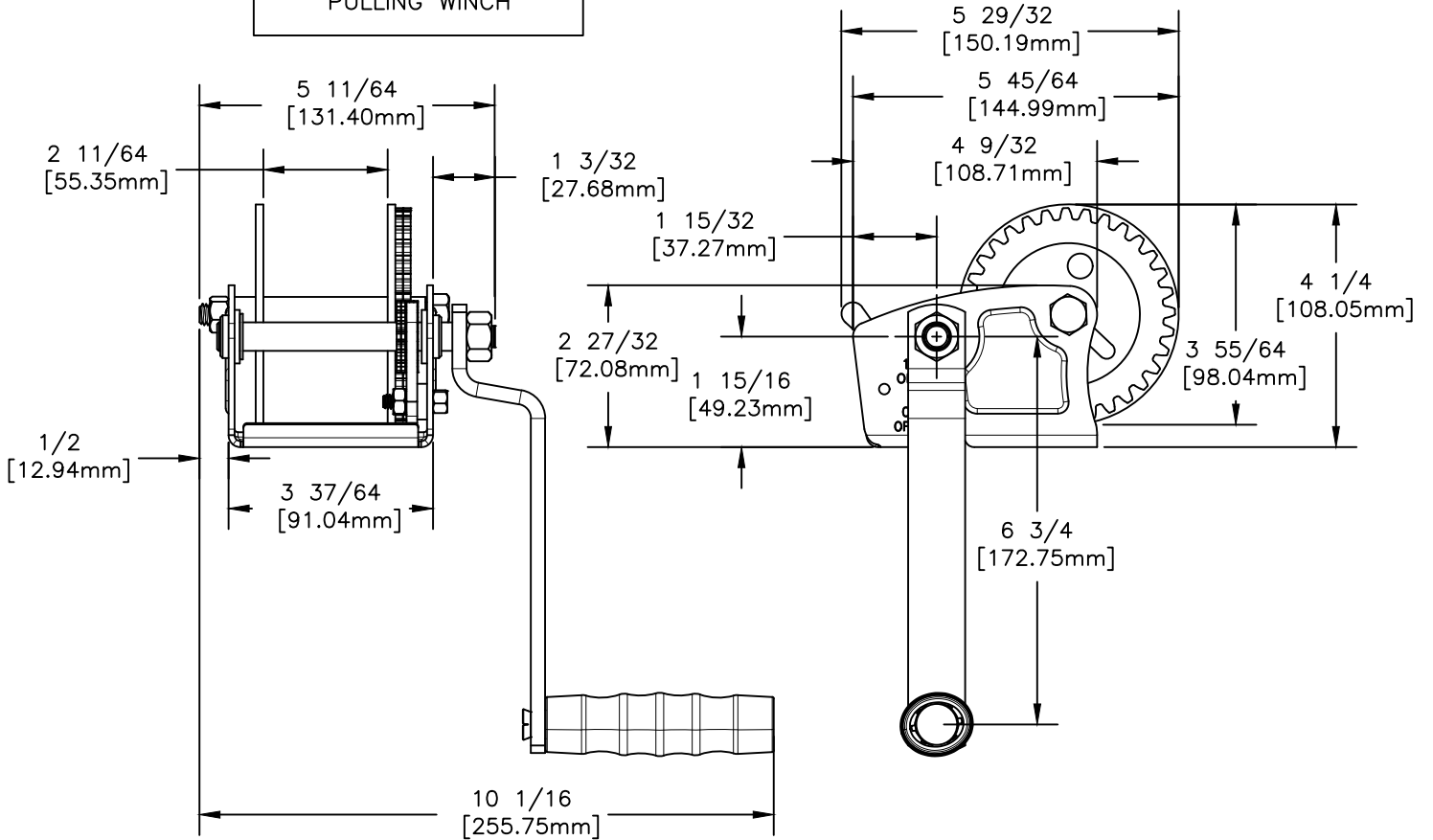

BASE HOLE PATTERN

