

MODEL
 DLC1400
 1400lb/635kg CAPACITY
 PULLING WINCH

FRONT & SIDE VIEW

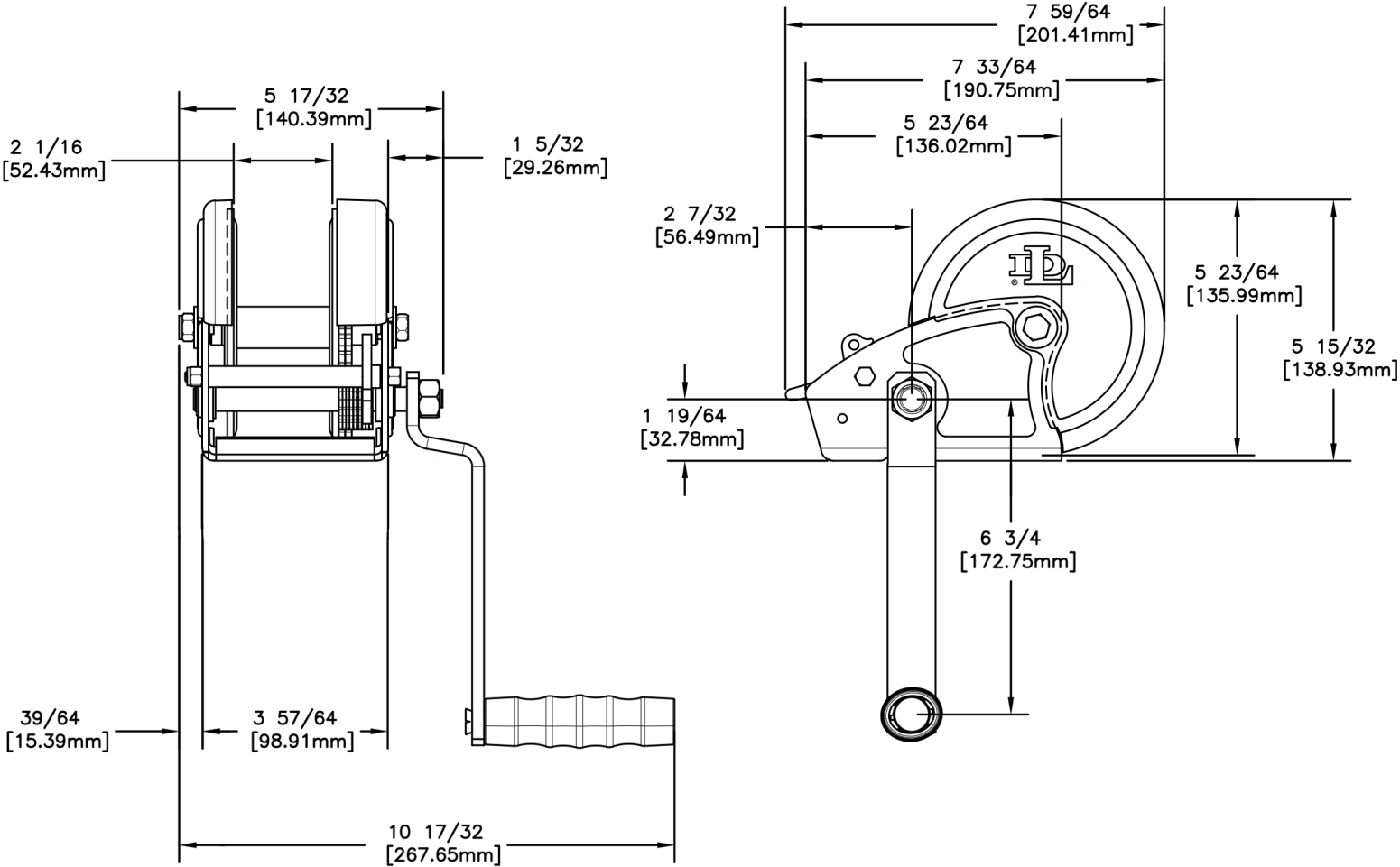

BASE HOLE PATTERN

