

MODEL
 CD5500
 DRUM HUB DIA. - 4 INCH
 GEAR RATIO - 24.4:1
 SINGLE LINE CAPACITY - 2750 LB/1247 KG
 DOUBLE LINE CAPACITY - 5500 LB/2495 KG
 BOAT LIFT WINCH

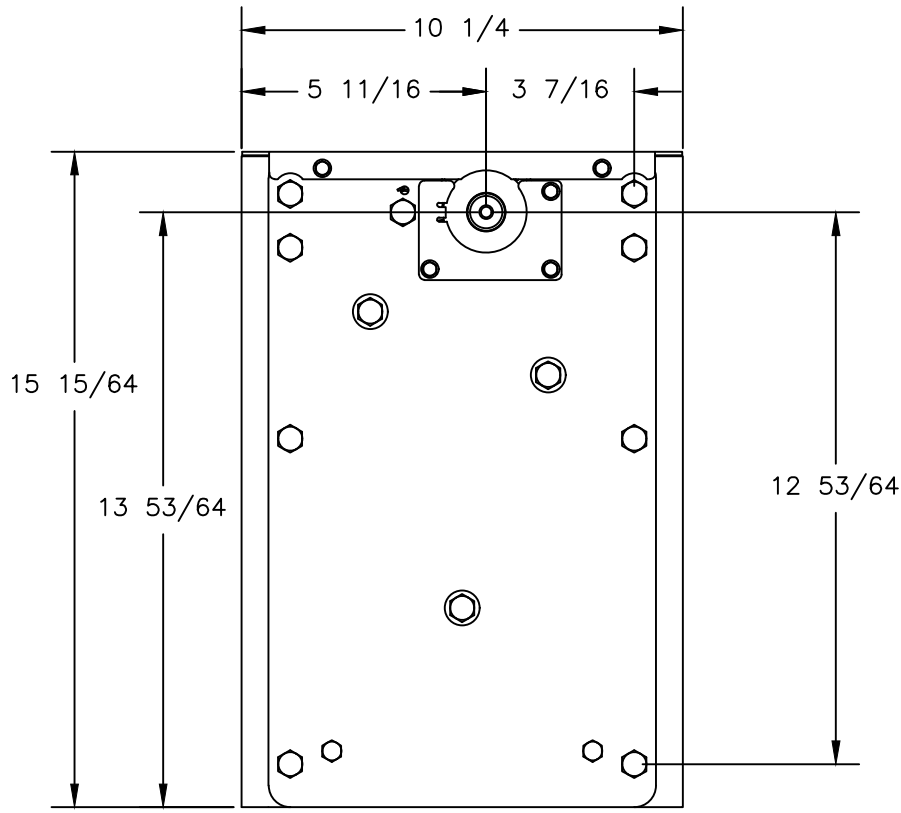

FRONT VIEW

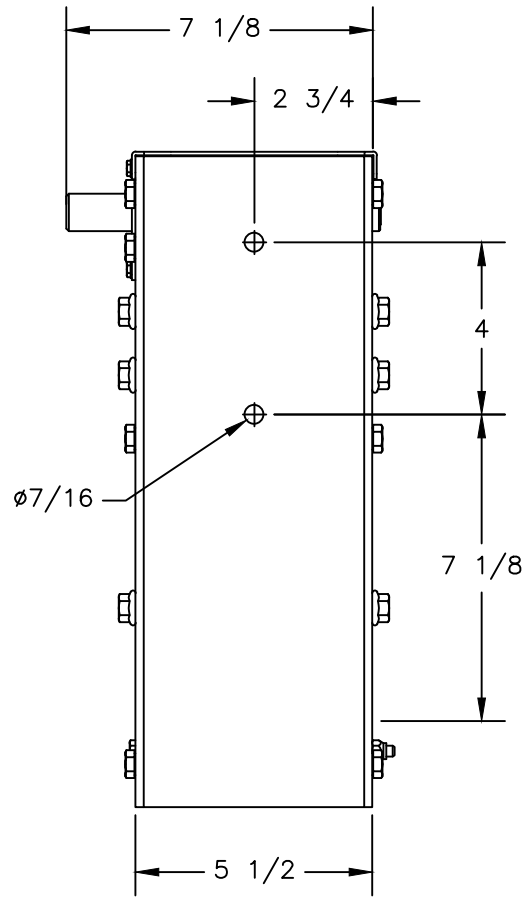

SIDE VIEW
 (MOUNTING HOLE
 PATTERN SAME ON
 BOTH SIDES)

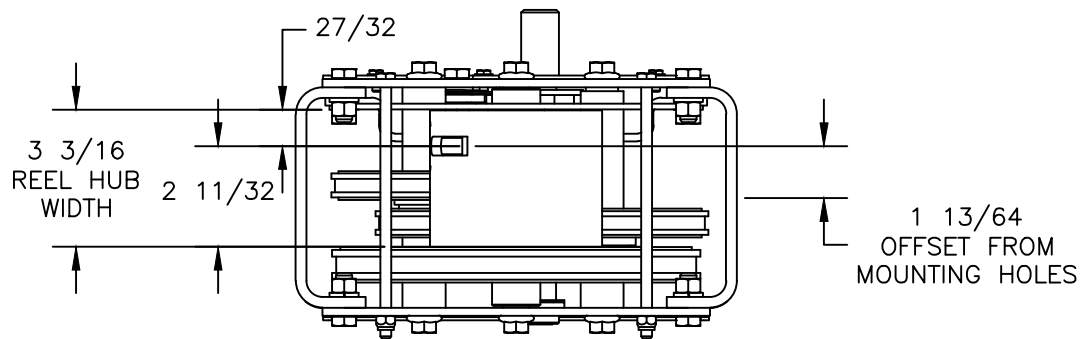

BOTTOM VIEW